

6th Gen Cubic Box PC

Features

- Fanless solution and compact housing
- 6th Gen Intel® Core™ i3 6100U / i5 6300U / i7 6600U Processor
- 4 x USB, 2 x RS232, 2 x GLAN, 1 x HDMI, 1 x DP
- 2 x Mini PCI-E slot
- Wall mount / DIN Rail installation
- IIoT gateway



Specifications

Model No.	CB068/026/069SD	CB068/026/069SW
SYSTEM		
CPU	6th Gen Intel® Core™ i3 6100U (068) / i5 6300U (026) / i7 6600U (069) CPU (On Board)	
Memory	1 x 260-pin DDR4 2133MHz SODIMM up to 16 GB	
H/W MONITOR		
H/W Monitor	Watch Dog Timer 256 Level	
I/O PORTS		
USB	4	
RS232	2	
GLAN	2	
HDMI	1	
DP	1	
STORAGE		
Storage	1 x SATA 3.0 2.5" HDD/SSD	
EXPANSION		
Mini PCI-E	1 x Full size with SIM socket, 1 x Full size with mSATA	
POWER REQUIREMENT		
Power Requirement	2 Pin power terminal block for DC in 12 ~ 24V	
OS SUPPORT		
OS support	Win Pro 7,8, 10 / Embedded Win 7, 8, 10 / Win 10 IoT / Fedora 25 Ubuntu 16.04	
MECHANICAL & ENVIRONMENTAL		
Operation Temp.	0 ~ 50°C	
Storage Humidity	10 ~ 90%, non-condensing	
Mounting	DIN Rail	Wall mount
Construction	Aluminum + Steel	
Dimension (WxHxD)	173 x 106 x 55 mm	
Weight	1.1 kg	
OPTIONAL		
P/N: 3080212019	1 x RS232/422/485	
P/N: 3080212019	2 x RS232	
P/N: 3080213001	Line out & MIC in for CB068/026/069SW	
P/N: 2390000003	external antenna (WIFI)	
P/N: 308020000B	USB cable	
P/N: 3121700002	4GB LTE module	

ORDERING INFORMATION

DIN Rail installation

CB068SD04064	Fanless DIN Rail Box PC, Intel i3 6100U, 4GB DDR 4 So-DIMM, TLC 64GB SSD, 1 x DC in external power adapter
CB026SD04064	Fanless DIN Rail Box PC, Intel i5 6300U, 4GB DDR 4 So-DIMM, TLC 64GB SSD, 1 x DC in external power adapter
CB069SD04064	Fanless DIN Rail Box PC, Intel i7 6600U, 4GB DDR 4 So-DIMM, TLC 64GB SSD, 1 x DC in external power adapter

Wall Mount installation

CB068SW04064	Fanless Wall Mount Box PC, Intel i3 6100U, 4GB DDR 4 So-DIMM, TLC 64GB SSD, 1 x DC in external power adapter
CB026SW04064	Fanless Wall Mount Box PC, Intel i5 6300U, 4GB DDR 4 So-DIMM, TLC 64GB SSD, 1 x DC in external power adapter
CB069SW04064	Fanless Wall Mount Box PC, Intel i7 6600U, 4GB DDR 4 So-DIMM, TLC 64GB SSD, 1 x DC in external power adapter

**If you select i3/i5/i7 for IIoT gateway, please contact us for further information. Our service email : sales@kingdy.com.tw

CB068/026/069SD

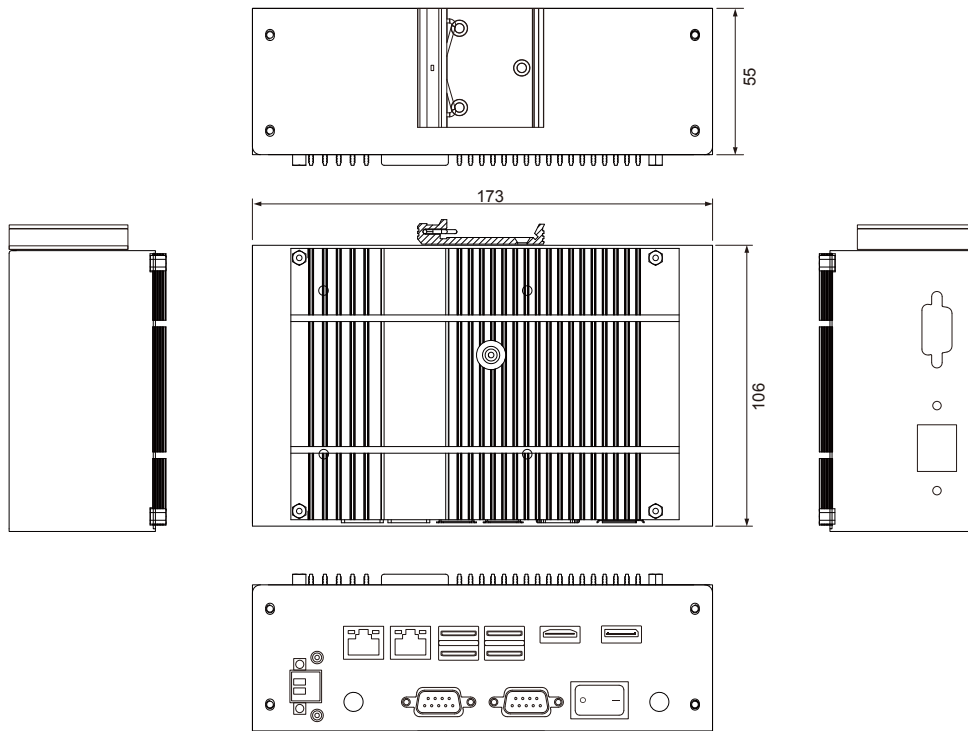

CB068/026/069SW

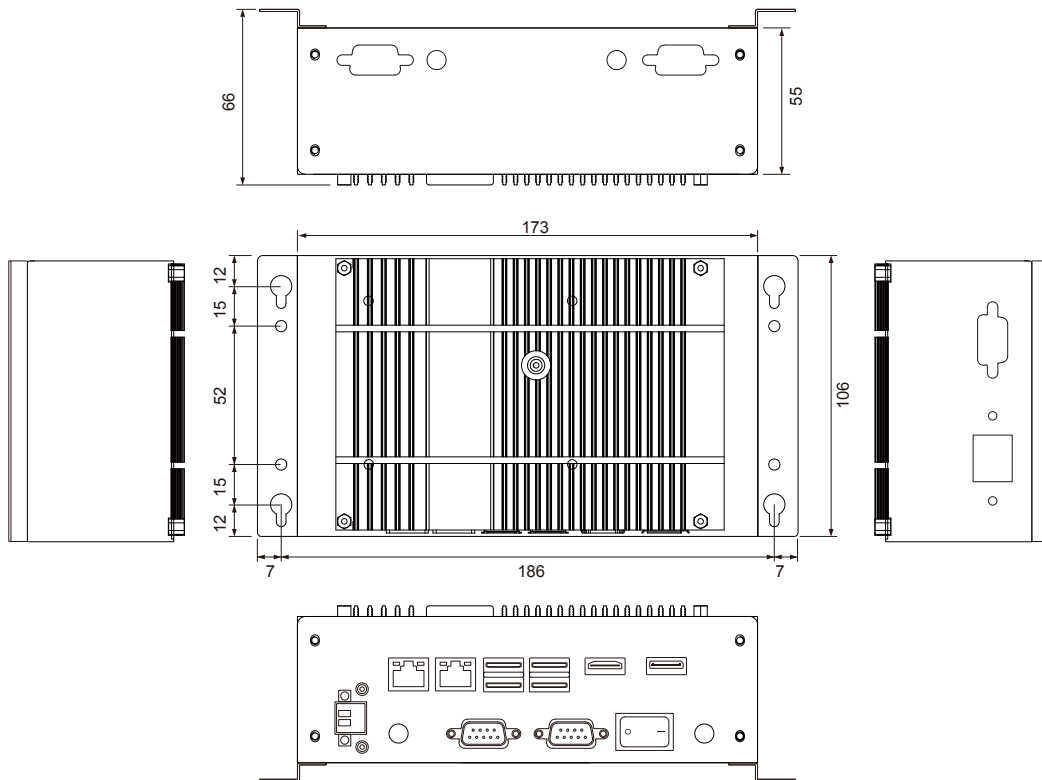

*Specifications are subject to change without notice.